



ISOL-CAR92
INSULATED CONDUCTOR RAIL
FOR ELECTRICAL FEEDING OF CRANES

Features, advantages and benefit

The insulated conductor rail system **CARIBONI**, series ISOLCAR92 is the best solution for the electric feeding of cranes, hoists and other mobile machines with continuous load up to 500A. ISOLCAR92 was designed and realized in order to offer the best guarantees against the accidental contact, according to the standard EN 60529. The conductor is made of copper (200A, 350A and 500A) or galvanized steel (110A).

Other characteristics which mark ISOLCAR92 are:

- High reliability
- Reduced encumbrance
- Easy and quick installation
- Possible installation either inside or outside, in humid and dusty environments
- Unlimited number of conductors
- Easy check and inspection
- Practically no maintenance costs



ISO9001

ISO14001

BS OHSAS 18001

CE MARK: it guarantees that Cariboni's products are complying with the European standards concerning safety of products.



Technical specifications

Load at ambient temperature 25 °C [A]				
Continuous	110	200	350	500
DC - 50%	160	300	500	700
Conductor material	Fe	Cu	Cu	Cu
Section [mm ²]	90	54	100	170
Resistance [$\Omega/m \cdot 10^{-4}$]	18,90	3,30	1,78	1,05
Impedance at 50 Hz [$\Omega/m \cdot 10^{-4}$]	18,95	3,57	2,35	1,82

Operating voltage	max 600 V
Rail sections length	4,5 m
Minimum spacing between conductors: Portata / Load 350-500 A	50 mm
Maximum support spacing	1,5 m
Admissible temperature for insulating housing: Standard housing High temperature housing	-30°C/+60°C -30°C/+85°C
Protection degree according to EN 60529	IP 23
Maximum travelling speed	200 m/1'
Inflammability (according to EN 60695-2-2)	Self-extinguishing



ISOL-CAR92

Components

Insulated conductor rail for electrical feeding of cranes

1 Insulated conductor rail**FEATURES:**

It is made of galvanized steel (110A) or copper (200A, 350A and 500A), inserted into an insulating housing. The insulating housing can be of standard type for operation temperature up to 60 °C (environment temperature + ΔT due to operation conditions) or fit for high temperature for temperature up to 85 °C. Conductor rails are supplied with length of 4.5m.

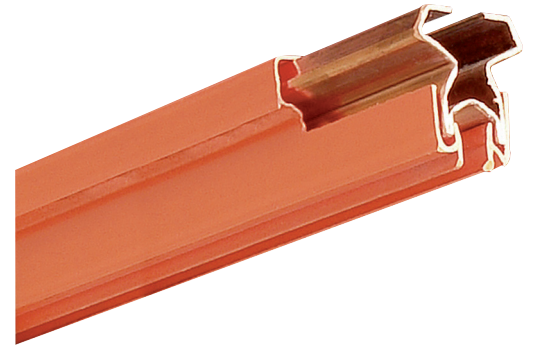

CODE	TEMPERATURE UP TO	LOAD (A)	L (m)	COLOR	WEIGHT (kg/m)
03.09501.90	60 °C	110A	4,50	orange	0,95
03.09501.91	85 °C			grey	
03.09502.90	60 °C	200A	4,50	orange	0,70
03.09502.91	85 °C			grey	
03.09503.90	60 °C	350A	4,50	orange	1,15
03.09503.91	85 °C			grey	
03.09504.90	60 °C	500A	4,50	orange	1,67
03.09504.91	85 °C			grey	

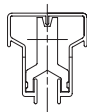
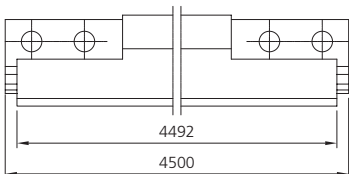
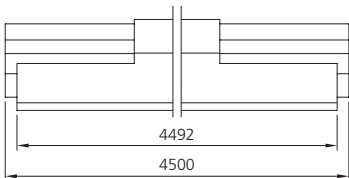
**Insulated conductor rail earth**

CODE	TEMPERATURE UP TO	LOAD (A)	L (m)	COLOR	WEIGHT (kg/m)
03.09501.90T	85 °C	110A	4,50	yellow / green	0,95
03.09502.90T	85 °C	200A	4,50	yellow / green	0,70
03.09503.90T	85 °C	350A	4,50	yellow / green	1,15

Earth

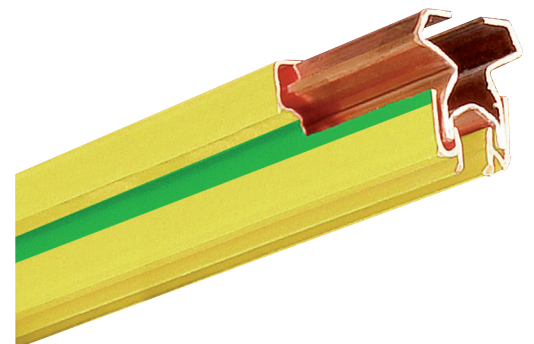

Insulated conductor rail for electrical feeding of cranes

2 Joint clamp

FEATURES:

It is used to joint two bars of insulated conductor rail. It is composed by an insulating box with and an inner clamp with galvanized steel or copper tightening screws.

CODE		TEMPERATURE UP TO	LOAD (A)	CONDUCTOR	WEIGHT (kg/pc)
STANDARD	ANTICORROSION				
03.09506.90	60 °C	110A	phase and earth	0,125
03.09506.92	85 °C			
03.09507.90	03.09507.91	60 °C	200A 350A	phase and earth	0,130
03.09507.92	03.09507.93	85 °C			
03.09508.91		60 °C	500A	phase and earth	0,380
03.09508.93		85 °C			

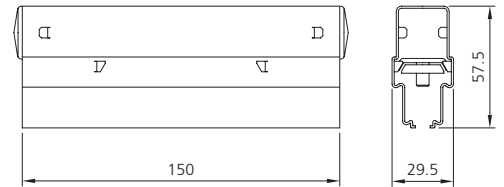

3 Feeder clamp

FEATURES:

It is used to connect the feeding cable to the conductor rail and has to be installed instead of a joint clamp (between two conductor rails). It is made of an insulating box with an inner clamp with galvanized steel or copper tightening screws to fasten the conductor to the feeding cable.

CODE		TEMPERATURE UP TO	LOAD (A)	CONDUCTOR	WEIGHT (kg/pc)
STANDARD	ANTICORROSION				
03.09506.90	60 °C	110A	phase and earth	0,125
03.09506.92	85 °C			
03.09507.90	03.09507.91	60 °C	200A 350A	phase and earth	0,130
03.09507.92	03.09507.93	85 °C			
03.09509.91		85 °C	350A	phase and earth	0,410
03.09509.93		85 °C	500A		0,580

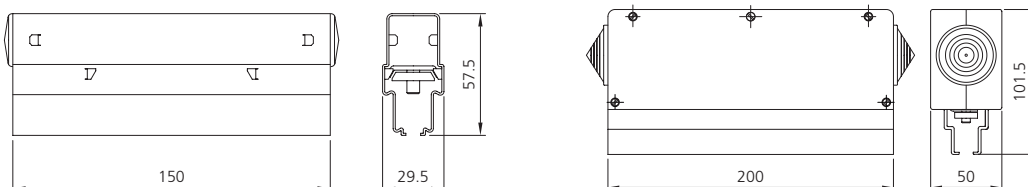

Insulated conductor rail for electrical feeding of cranes

4 Expansion joint

FEATURES:

It is used for long lines in order to compensate the linear expansion of the conductor rail due to thermal effect; therefore the expansion joint prevents from possible deformation of the line. It is made of two sliding pieces of conductor rail, supported by two support hangers and two feeder clamps connected by a flexible electric cable.

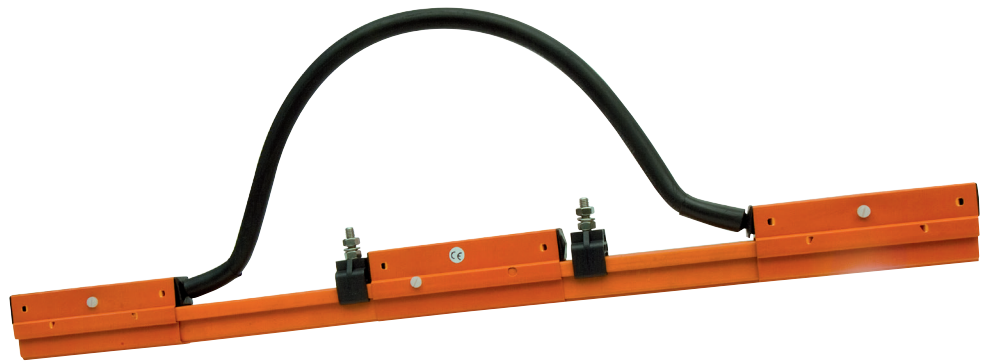

CODE		TEMPERATURE UP TO	LOAD (A)	CONDUCTOR	WEIGHT (kg/pc)
STANDARD	ANTICORROSION				
03.09516.90N	60 °C	110A	phase	1,300
03.09516.90NT			earth	
03.09516.92N	85 °C	110A	phase	1,300
03.09516.92NT			earth	
03.09517.91N		60 °C	200A	phase	1,350
03.09517.91NT				earth	
03.09517.93N		85 °C	200A	phase	1,350
03.09517.93NT				earth	

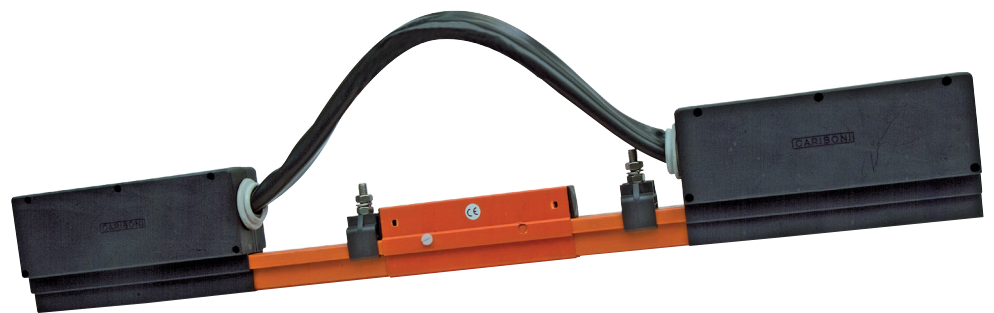
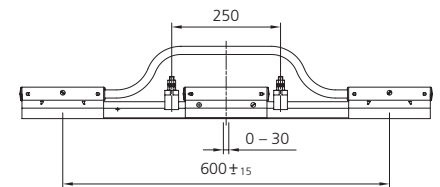

CODE		TEMPERATURE UP TO	LOAD (A)	CONDUCTOR	WEIGHT (kg/pc)
STANDARD	ANTICORROSION				
03.09518.91NN		60 °C	350A	phase	2,350
03.09518.91NNT				earth	
03.09518.93NN		85 °C	350A	phase	2,350
03.09518.91NNT				earth	
03.09519.91N		60 °C	500A	phase	3,200
03.09519.91NT				earth	
03.09519.93N		85 °C	500A	phase	3,200
03.09519.93NT				earth	

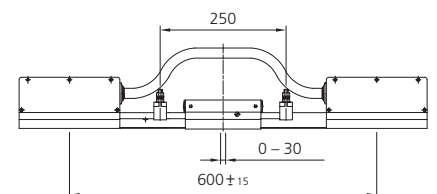

5 Section joint

FEATURES:

It is used to divide the line into 2 or more insulated sections. It is made of an insulating section of conductor rail with two joint clamp and it is supported by one support hanger. The earth conductor rail doesn't need section joints.

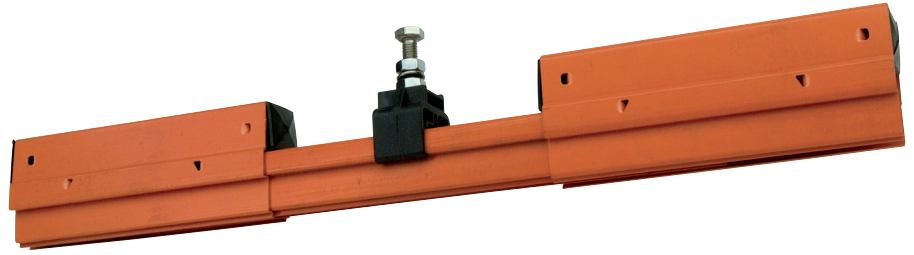

CODE		TEMPERATURE UP TO	CONDUCTOR	WEIGHT (kg/pc)
STANDARD	ANTICORROSION			
03.09521.90N	60 °C	phase	0,550
03.09522.91N				0,500
03.09523.91N				0,600
03.09521.92N	85 °C	phase	0,550
03.09522.93N				0,500
03.09523.93N				0,600
03.09524.91N		60 °C	phase	1,400
03.09524.93N		85 °C		

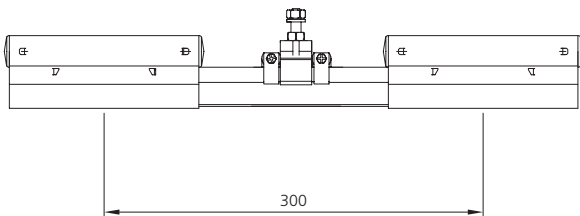

6 Insulated end cap

FEATURES:

It is insulating and it is used to close the extremities of the line.

CODE	COLOUR	WEIGHT (kg/pc)
7.21.00.0629	black	0,005

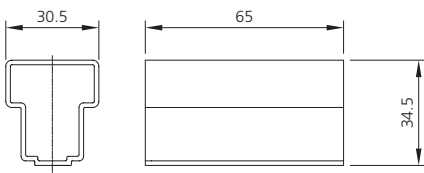
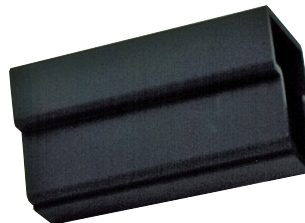

Insulated conductor rail for electrical feeding of cranes

7 Fixed point hanger**FEATURES:**

It is made of insulating material and used to share the expansion of the conductor rail. It has to be fixed to a support hanger placed in the middle of the line between two expansion joints or between an expansion joint and the end of the line.

CODE	HARDWARE	COLOUR	WEIGHT (kg/pc)
03.09625.90	Stainless steel	black	0,185

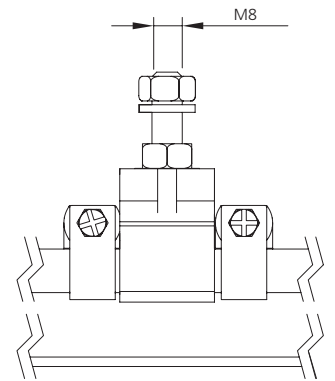
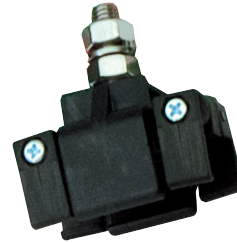
**8** Support hanger**FEATURES:**

It is used to support the conductor rail and it is made of insulating material; it is fit by click to the conductor rail and then fixed to a support bracket. Support hangers are installed with a pitch max of 1.5m.

CODE	HARDWARE	COLOUR	WEIGHT (kg/pc)
03.09526.90N	Galvanized steel	black	0,050
03.09526.91N	Stainless steel	black	0,050

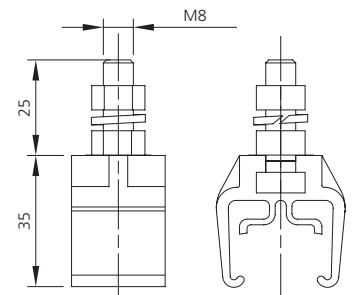
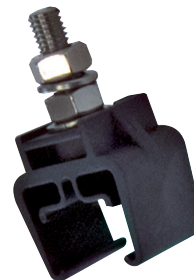
**9** Simple current collector - Load 100 A**FEATURES:**

The simple (100A) current collector is flexible in order to compensate any displacements of the crane. The copper graphite contact shoe is easy to be replaced and is protected by an insulating sheath.

CODE	CONDUCTOR	WEIGHT (kg/pc)
03.09536.91N	phase	0,70
03.09536.91NT	earth	0,70

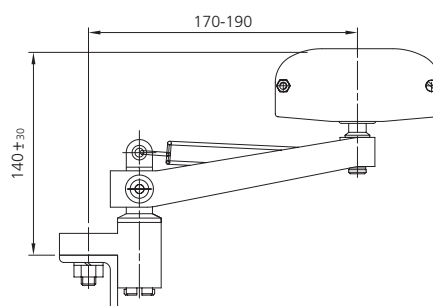

10 Double current collector - Load 200 A

FEATURES:

The double (2x100A) current collector is flexible in order to compensate any displacements of the crane. The copper graphite contact shoe is easy to be replaced and is protected by an insulating sheath.

CODE	CONDUCTOR	WEIGHT (kg/pc)
03.09537.91N	phase	1,700
03.09537.91NT	earth	

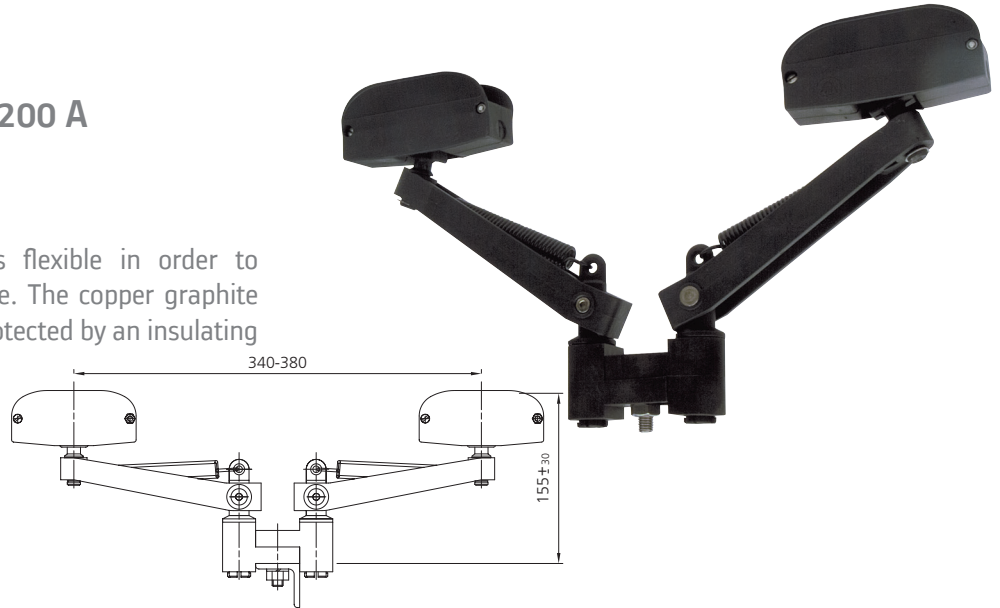

11 Feeder connector

FEATURES:

It is used to connect the feeding cable to the feeder clamps.

CODE	LOAD (A)	MAX CABLE mm ²	DIMENSIONS			WEIGHT (kg/pc)
			A	B	Ø	
81.40000.12	110A	25	32	13	6,4	0,012
81.40000.13	200A	50	42	20	6,4	0,020
81.40000.23	350A	95	53,5	27	8,4	0,040
81.40000.24	500A	120	63,5	29	12,5	0,070

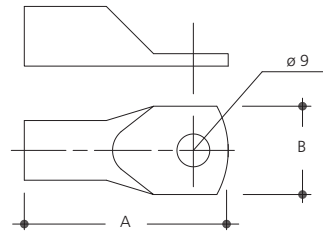

SPARE PARTS

12 Contact shoe

CODE	WEIGHT (kg/pc)
7.13.00.0046M	0,080

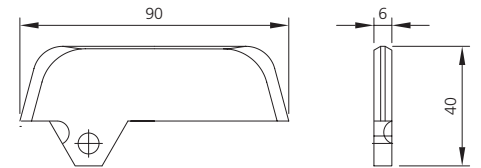

13 Insulated shoe holder

CODE	WEIGHT (kg/pc)
03.09556.91	0,090

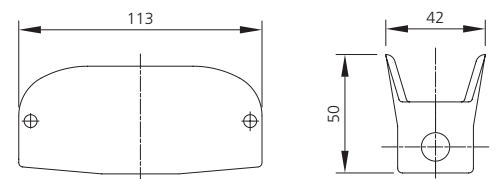

14 Tension spring

CODE	WEIGHT (kg/pc)
7.14.00.0167P	0,055

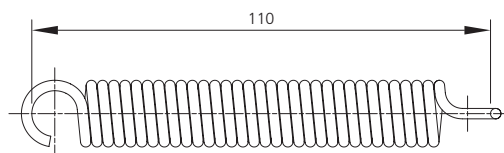

Example of a possible installation

- 1 INSULATED CONDUCTOR RAIL
- 2 RIGID JOINT CLAMP
- 3 FEEDER CLAMP
- 4 EXPANSION JOINT
- 5 SECTIONALIZING JOINT
- 6 END CAP
- 7 FIXED POINT HANGER
- 8 SUPPORT HANGER
- 9-10 SIMPLE AND DOUBLE CURRENT COLLECTOR

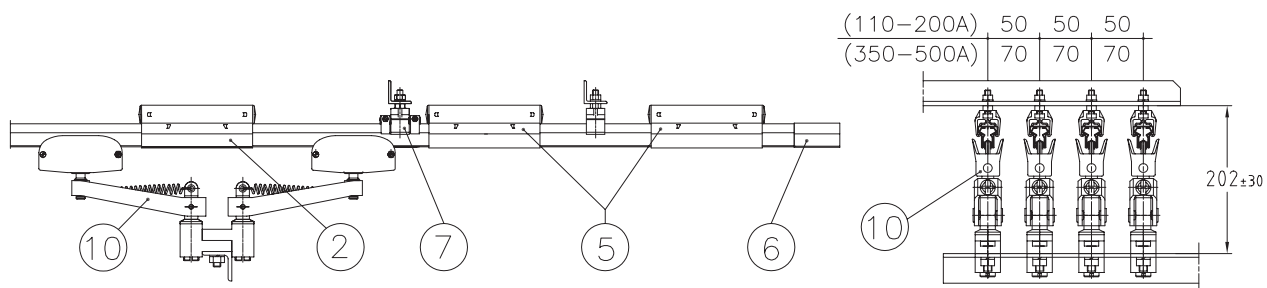
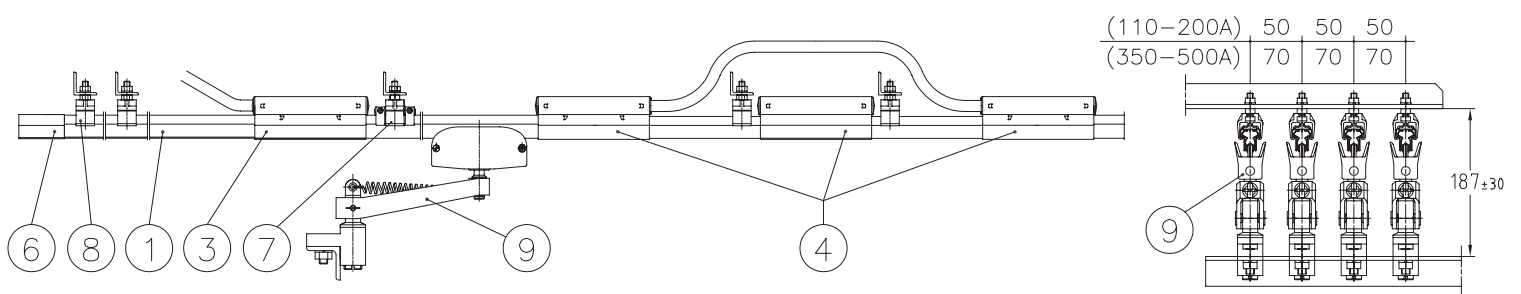
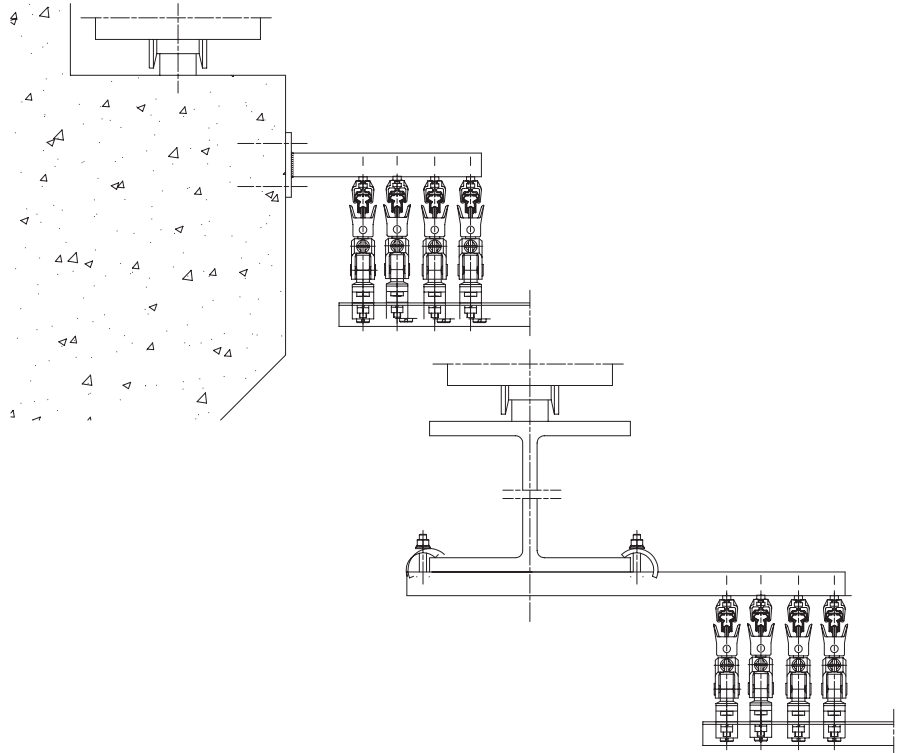



ALSTOM FERROVIARIA S.p.A.

I- 23855 Pescate (LC) Via Roma, 14

Tel. ++39/0341.358711 - Fax ++39/0341.364672

E-mail: alstom.lecco@alstomgroup.com - <http://www.alstom.com>